

Turmdrehkran

Tower Crane / Grue à tour / Gru a torre / Grúa torre
Guindaste de torre / Башенный поворотный кран

130 EC-B 8 FR.tronic®

130 EC-B 6

▶ **130 EC-B 8 FR.tronic®**

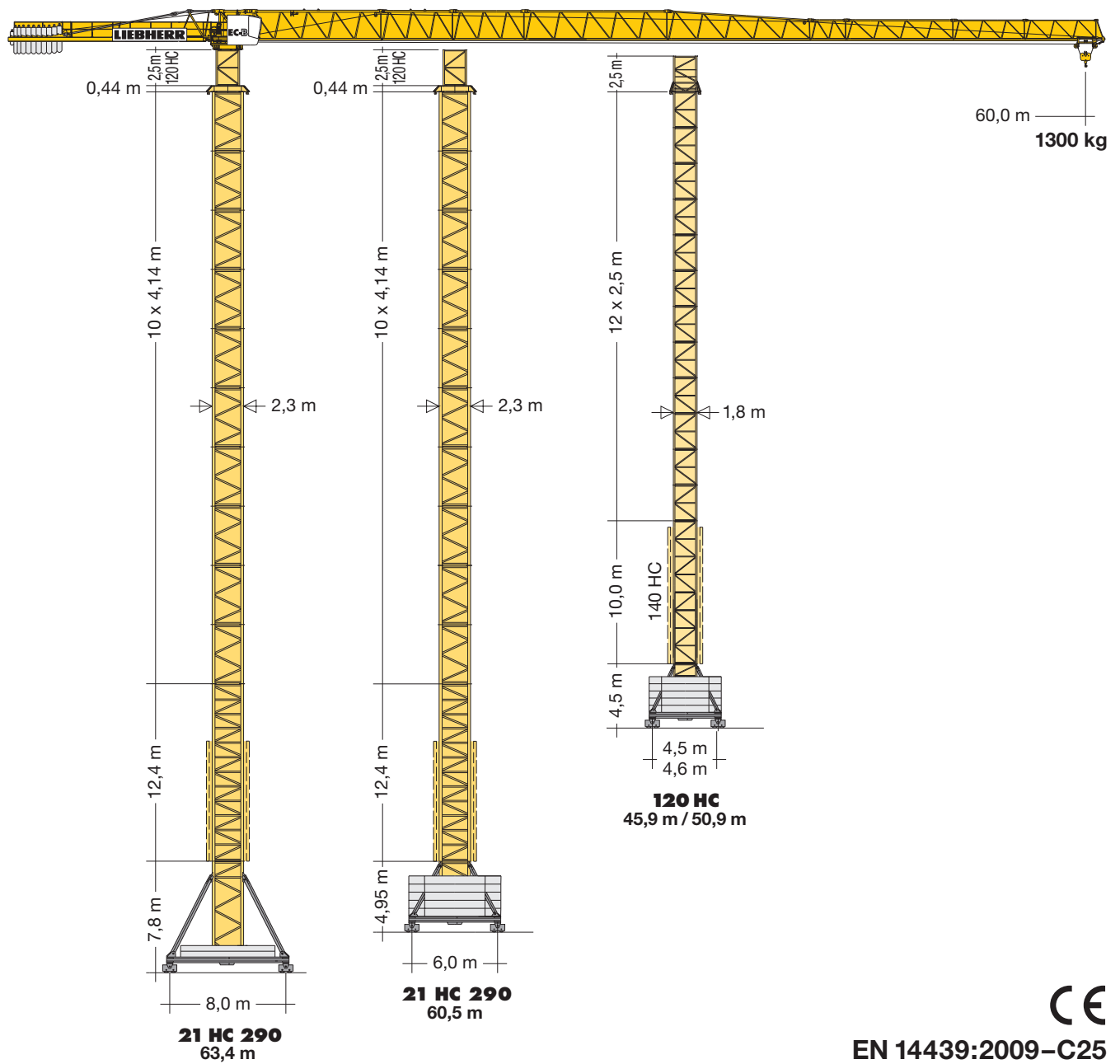

EN 14439:2009-C25

LIEBHERR

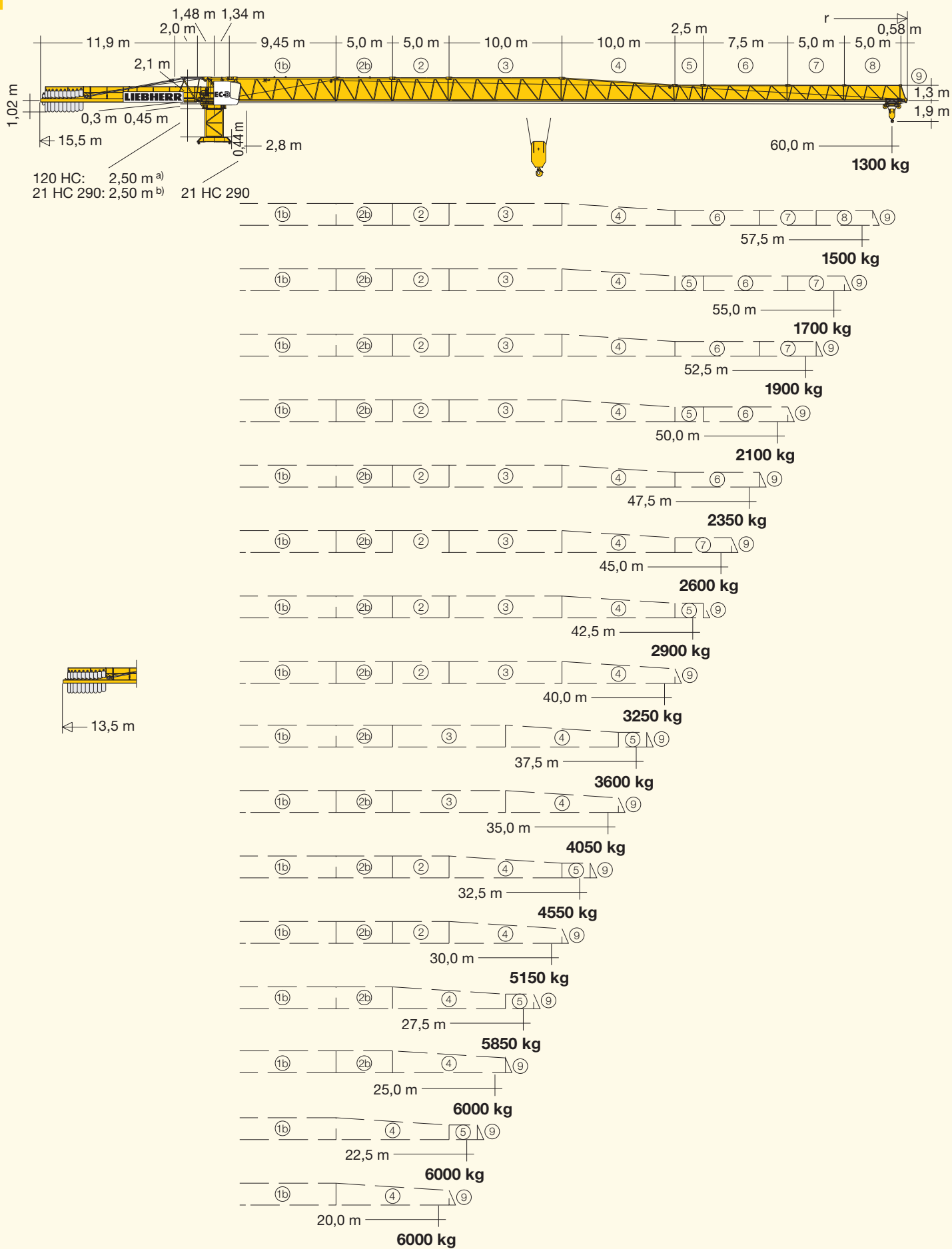

a) **Turmstück oder Kletterturmstück.** / Tower section or climbing tower section.
Élément de mât ou élément de mât télescopable. / Elemento torre oppure elemento torretelescopabile. / Tramo torre o tramo torre trepable. / Segmento de torre ou segmento de torre para ascensão. / Башенная секция или секция наращивания

b) **Turmstück 120 HC.** / Tower section 120 HC.
Élément de mât 120 HC. / Elemento di torre 120 HC.
Tramo torre 120 HC. / Segmento de torre 120 HC.
Башенная секция 120 HC.

Ausladung und Tragfähigkeit

Radius and capacity / Portée et charge / Sbraccio e portata
Alcances y cargas / Alcance e capacidade de carga / Вылет и грузоподъемность

130 EC-B 8 FR.tronic®

m	r	m/kg	m/kg																		
			15,0	17,5	20,0	22,5	25,0	27,5	30,0	32,5	35,0	37,5	40,0	42,5	45,0	47,5	50,0	52,5	55,0	57,5	60,0
60,0	(r = 61,5)	2,8-13,9 8000	7340	6180	5320	4650	4110	3670	3310	3000	2730	2500	2300	2120	1970	1830	1700	1590	1480	1390	1300
57,5	(r = 59,0)	2,8-14,6 8000	7770	6550	5640	4940	4370	3910	3520	3200	2920	2680	2460	2280	2110	1960	1830	1710	1600	1500	
55,0	(r = 56,5)	2,8-15,3 8000	8000	6870	5920	5180	4590	4110	3710	3370	3070	2820	2600	2410	2230	2080	1940	1810	1700		
52,5	(r = 54,0)	2,8-15,8 8000	8000	7130	6140	5380	4770	4270	3860	3500	3200	2940	2710	2510	2330	2170	2030	1900			
50,0	(r = 51,5)	2,8-16,2 8000	8000	7330	6320	5540	4910	4400	3970	3610	3300	3040	2800	2600	2410	2250	2100				
47,5	(r = 49,0)	2,8-16,7 8000	8000	7610	6560	5750	5110	4580	4130	3760	3440	3170	2920	2710	2520	2350					
45,0	(r = 46,5)	2,8-17,1 8000	8000	7820	6750	5910	5250	4710	4260	3870	3550	3260	3010	2790	2600						
42,5	(r = 44,0)	2,8-17,6 8000	8000	8000	6970	6110	5430	4870	4400	4010	3670	3380	3130	2900							
40,0	(r = 41,5)	2,8-18,2 8000	8000	8000	7210	6330	5620	5050	4570	4160	3820	3510	3250								
37,5	(r = 39,0)	2,8-18,6 8000	8000	8000	7370	6470	5750	5170	4680	4260	3910	3600									
35,0	(r = 36,5)	2,8-19,1 8000	8000	8000	7620	6690	5950	5350	4840	4420	4050										
32,5	(r = 34,0)	2,8-19,6 8000	8000	8000	7840	6890	6130	5510	4990	4550											
30,0	(r = 31,5)	2,8-20,2 8000	8000	8000	8000	7100	6320	5680	5150												
27,5	(r = 29,0)	2,8-20,7 8000	8000	8000	8000	7310	6510	5850													
25,0	(r = 26,5)	2,8-19,3 8000	8000	8000	7680	6750	6000														
22,5	(r = 24,0)	2,8-17,3 8000	8000	7920	6840	6000															
20,0	(r = 21,5)	2,8-15,4 8000	8000	6960	6000																

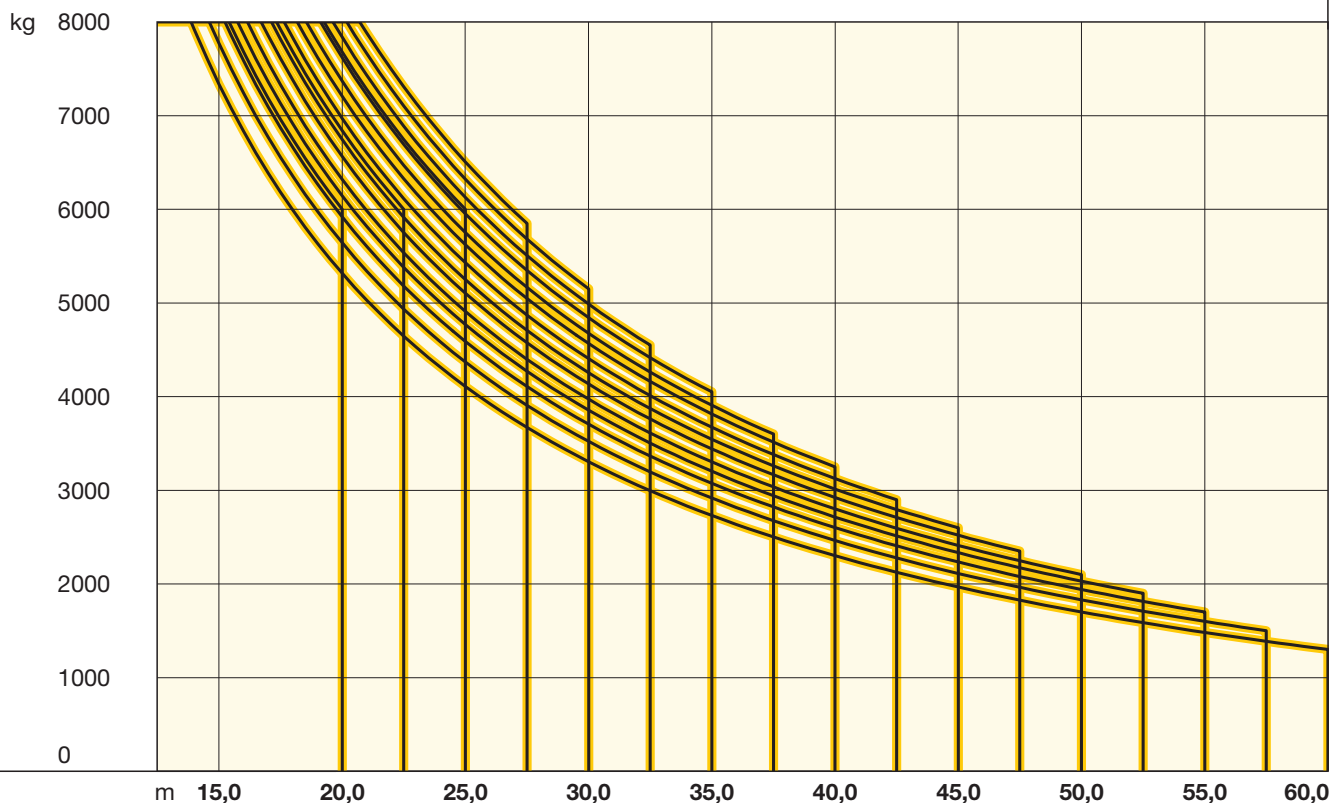



120 HC												
C 25												
14	47,7 ³⁾	50,9 ¹⁾	47,2 ³⁾	50,4 ¹⁾	44,8 ³⁾	48,0 ³⁾	43,4 ³⁾	46,6 ³⁾	-	-	-	-
13	45,2 ²⁾	48,4 ³⁾	44,7 ²⁾	47,9 ³⁾	42,3 ²⁾	45,5 ²⁾	40,9 ²⁾	44,1 ²⁾	-	-	42,4 ⁴⁾	-
12	42,7 ²⁾	45,9 ²⁾	42,2 ²⁾	45,4 ²⁾	39,8 ²⁾	43,0 ²⁾	38,4 ²⁾	41,6 ²⁾	39,9 ²⁾	-	39,9 ²⁾	43,1 ⁴⁾
11	40,2	43,4 ²⁾	39,7	42,9 ²⁾	37,3	40,5 ²⁾	35,9 ²⁾	39,1 ²⁾	37,4 ²⁾	40,6 ²⁾	37,4 ²⁾	40,6 ²⁾
10	37,7	40,9	37,2	40,4	34,8	38,0	33,4	36,6	34,9	38,1 ²⁾	34,9 ²⁾	38,1 ²⁾
9	35,2	38,4	34,7	37,9	32,3	35,5	30,9	34,1	32,4	35,6 ²⁾	32,4	35,6
8	32,7	35,9	32,2	35,4	29,8	33,0	28,4	31,6	29,9	33,1	29,9	33,1
7	30,2	33,4	29,7	32,9	27,3	30,5	25,9	29,1	27,4	30,6	27,4	30,6
6	27,7	30,9	27,2	30,4	24,8	28,0	23,4	26,6	24,9	28,1	24,9	28,1
5	25,2	28,4	24,7	27,9	22,3	25,5	20,9	24,1	22,4	25,6	22,4	25,6
4	22,7	25,9	22,2	25,4	19,8	23,0	18,4	21,6	19,9	23,1	19,9	23,1
3	20,2	23,4	19,7	22,9	17,3	20,5	15,9	19,1	17,4	20,6	17,4	20,6
2	17,7	20,9	17,2	20,4	14,8	18,0	13,4	16,6	14,9	18,1	14,9	18,1
1	15,2	18,4	14,7	17,9	12,3	15,5	10,9	14,1	12,4	15,6	12,4	15,6
0	12,7	15,9	12,2	15,4	9,8	13,0	8,4	11,6	9,9	13,1	9,9	13,1
	m a)	b)	m a)	b)	m a)	b)	m a)	b)	m a)	b)	m a)	b) 5) b) 6)

21 HC 290			
C 25			
12		64,1 ²⁾	-
11		60,0 ²⁾	-
10		55,9	60,5 ²⁾
9		51,7	56,4
8		47,6	52,3
7		43,4	48,1
6		39,3	44,0
5		35,2	39,8
4		31,0	35,7
3		26,9	31,6
2		22,7	27,4
1		18,6	23,3
0		14,5	19,1
	m		

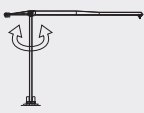
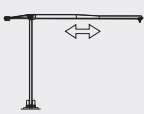

Weitere Hubhöhen sowie Klettern auf Anfrage. / Further hoist heights and climbing on request. / Hauteurs sous crochet plus élevées et hissage sur demande. / Altre altezze di sollevamento come pure telescopaggio, su richiesta. / Para alturas bajo gancho superiores y trepado, consultar. / Outras alturas de elevação e ascensionamento, mediante consulta. / Другие высоты подъема и наращивание крана – по запросу.

	U/min 0 ↔ 0,8 sl./min tr./min	7,5 kW FU
	0 ↔ 60,0 m/min	5,4 kW FU
	25,0 m/min	2 x 4,0 kW
	kVA	37 kW FU 47,0

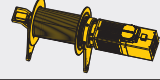

↔ **stufenlos**/stepless / régl. continu
regl. progressiva / sin escalones / sem degraus
бесступенчатый kg m/min

37 kW FU
WIW 250 MZ 419

5 Lagen
Layers
Couches
Avvolgimenti
Camadas
Сарап
Слоёв

110,0 m

190,0 m⁷⁾

1	8000	0 ↔ 24
	700	0 ↔ 130

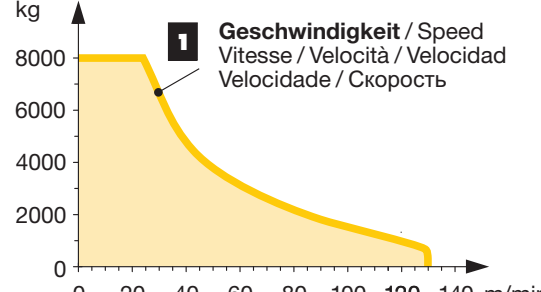

1 **Geschwindigkeit / Speed**
Vitesse / Velocità / Velocidad
Velocidade / Скорость

kg

8000

6000

4000

2000





















0

0 20 40 60 80 100 120 140 m/min

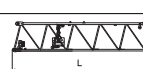
⁷⁾ Weitere Hublastdaten: siehe Betriebsanleitung. / Further hoist load data: see instruction manual. / Autres données de la charge de levage: voir manuel d'instruction. / Altri dati sui carichi sollevati: consultare il manuale d'istruzione. / Alturas bajo granco superiores según manual. / Outras tabelas de carga: consultar manual de instruções. / Другие данные по весу поднимаемых грузов: см. инструкцию по эксплуатации.

Kolli-Liste Packing List / Liste de colisage / Lista dei colli
Lista de contenido / Lista de embalagem / Упаковочный лист

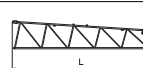
Montagegewichte: siehe Betriebsanleitung. / Erection weights: see instruction manual. / Poids de montage: voir manuel de service. / Pesi di montaggio: vedere manuale d'uso. / Peso para el montaje: según manual. / Pesos de montagem: veja-se as instruções p. uso. / Масса монтируемых частей: см. инструкцию по эксплуатации.

Kranoberteil		Upper part of crane / Partie supérieure de grue / Parte superiore della gru Parte superior grúa / Parte superior do guindaste / Верхняя часть крана	L (m)	B (m)	H (m)	kg ⁸⁾		
Pos. Item Rep Voce Pos. Ref. Поз.	Anz. Qty. Qte. Qta. Cant. Кол-во	Drehbühne mit Podesten / Slewing platform with platforms Plate-forme tournante avec plates-formes / Piattaforma girevole con pedana / Plataforma giratória con plataforma Plataforma giratória com plataforma / Поворотная платформа с площадками			3,03	3,35	2,83 (2,51)	7810
1	1							
2	1	Drehbühne / Slewing platform / Ensemble mât-cabine / Piattaforma girevole / Conjunto plataforma de giro / Plataforma giratória Поворотная платформа			3,03	2,43	2,83 (2,51)	7380
3	1	Podeste / Platformes / Plates-formes Pedana / Plataformas / Plataformas Площадки			2,80 3,09 2,80	1,10 0,79 1,12	1,24 1,29 1,22	250 200 170
4	1	Kabine / Cabin / Cabine Cabina / Cabina / Cabina Кабина			3,60 ⁹⁾ 3,60	1,49 ⁹⁾ 1,49	2,29 ⁹⁾ 2,26	900 ⁹⁾ 810
5	1	Gegenausleger-Anlenkstück / Counter-jib heel section Pied de contre-flèche / Settore articolato di controbraccio Tramo primero-contrapluma / Base articulada da contra-lança Корневая секция консоли противовеса			2,75	1,20	2,25	760
6	1	Gegenausleger / Counter-jib / Contre-flèche Controffreccia / Contrapluma / Contra-lança Консоль противовеса			11,98	1,40	0,81	2700
7	1	Podeste Gegenausleger / Counter-jib platforms Plates-formes de contre-flèche / Ballatoi controffreccia Plataforma contrapluma / Plataforma contra-lança Площадки консоли противовеса			4,00	0,69	1,35	180
8	1	Ausleger-Anlenkstück / Jib heel section / Pied de flèche Sezione articolata braccio / Pluma tramo primero / Base articulada de lança / Корневая секция стрелы			9,67	1,34	2,25	⊕ 2270
9	1	Ausleger-Zwischenstück / Intermediate jib section Élément intermédiaire de flèche / Sezione intermedia braccio / Tramo intermedio pluma / Peça suplementar da lança / Промежуточная секция стрелы			5,26 5,27 10,26 2,72 7,71 5,19 5,17	1,20 1,20 1,20 1,20 1,20 1,20 1,20	2,15 2,15 2,14 1,48 1,48 1,46 1,45	⊕ 850 ⊕ 760 ⊕ 1170 ⊕ 200 ⊕ 520 ⊕ 240 ⊕ 200
10	1	Ausleger-Zwischenstück / Intermediate jib section Élément intermédiaire de flèche / Sezione intermedia braccio / Tramo intermedio pluma / Peça suplementar da lança / Промежуточная секция стрелы			10,22	1,20	2,08	⊕ 900

Pos. Item Rep. Voce Pos. Ref. Pos.	Anz. Qty. Qte. Qta. Cant. Cant. Cant.				L (m)	B (m)	H (m)	kg ⁸⁾
11	1	Ausleger-Kopfstück / Jib head section / Pointe de flèche / Punta braccio / Tramo punta de pluma / Cabeça de lança / Концевая секция стрелы						85
12	1	Laufkatze / Trolley / Chariot / Carrello / Carrito / Carrinho / Грузовая тележка						550
13	1	Fahrkorb / Maintenance cage / Nacelle d'entretien / Cestello di manutenzione / Plataforma de mantenimiento / Передвижная платформа						35

Turm Tower / Mât / Torre Torre / Torre / Башня

14	15	Turmstück / Tower section			120 HC	2,50	1,80	1,80	1090
	10	Elément de mât / Elemento di torre			21 HC 290 TS-0414c	4,14	2,30	2,30	2300
	12	Tramo torre / Torre / Башенная секция							
15	7	Turmstück lang / Long tower section			120 HC	5,00	1,80	1,80	1830
	3	Elément de mât long / Elemento di torre, lungo / Tramo de torre largo / Peça de torre, comprida / Башенная секция, длинная			120 HC	10,00	1,80	1,80	3430
					120 HC	12,50	1,80	1,80	4200
16	1	Grundturmstück / Base tower section			140 HC	6,85	1,80	1,80	2930
		Mât de base / Elemento di torre base / Tramo base / Peça de base de torre / Секция основания			140 HC	10,00	1,80	1,80	3990
					21 HC 290 TS-1242c	(12,42)	(2,30)	(2,30)	(7940)
17	1	Kletterturmstück / Climbing tower section			120 HC	2,75	2,20	2,45	1450
		Elément de hissage de mât / Elemento torre di telescopaggio / Tramo de trepado / Tramo de telescopagem / Секция самоподъема							

Klettereinrichtung Climbing equipment / Equipement de télescope / Attrezzatura per allungamento della gru Equipo de equipo / Acessórios p. subida no edificio / Обоймы наращивания

18	1	Führungsstück kpl. / Guide section cpl. / Cage télescopique cpl. / Gabbia di sopraelevazione compl. / Torre de montaje completa / Peça de guia compl. / Направляющая секция в сб.			120 HC	6,45	2,10	2,42	3500
					120 HC	9,60	2,10	2,42	4440
					21 HC 290	8,39	2,68	2,58 (3,04)	5200
19	1	Hydraulikanlage, Stütz- und Klettertraverse / Hydraulic unit, supporting and climbing cross members / Système hydraul. avec traverses d'appui et de télescop. / Sist. idraul., traversa di appoggio e allugam. gru / Sistema hidráulico con traviesa de apoyo y trepado / Instalação hidráulica, travessa de apoio e subida / Гидроагрегат, стойка-упор и трверса обоймы наращивания			120 HC	2,87	2,12	1,06	1050
					21 HC 290	2,30	1,25	1,00	1150

Unterwagen Undercarriage / Châssis / Carro Carro con mástil / Carro de guindaste / Опорная рама

20	2	Fahrschemel mit Antrieb / Rail bogie with drive			120 HC	1,38	0,88	0,87	900
		Bogie moteur / Telaço con grappa propulsore / Caja rodillo motriz / Quadra sem grupa de propulsão / Подрамник с приводом			21 HC 290	1,63 (1,46)	0,92 (0,84)	0,95 (0,87)	1690 (920)
21	2	Fahrschemel ohne Antrieb / Rail bogie without drive			120 HC	1,17	0,60	0,87	860
		Bogie fou / Telaço senza grappa propulsore / Caja rodillo conducido / Quadra com grupa de propulsão / Подрамник без привода			21 HC 290	1,37 (1,15)	0,62 (0,60)	0,95 (0,87)	1340 (880)
22	1	Tragholm lang / Long support arm / Longeron long / Longherone lungo / Brazo soporte largo / Travessa comprida / Несущая балка, длинная			120 HC	7,12	0,78	0,65	950
					21 HC 290	9,10 (11,95)	0,80 (0,82)	0,80 (0,80)	1650 (2200)
23	2	Tragholm kurz / Short support arm / Longeron court / Longherone corto / Brazo soporte corto / Travessa curta / Несущая балка, короткая			120 HC	3,45	0,56	0,55	408
					21 HC 290	4,45 (5,58)	0,77 (0,65)	0,77 (0,77)	800 (1035)
24	2 + 2	Randträger / Border support / Traverse			120 HC	4,02	0,35	0,12	95
		Supporti base / Traviesa / Apoio de bordo / Стяжная балка			21 HC 290	5,46 - 5,40 (7,52 - 7,46)	0,11 - 0,18 (0,10 - 0,17)	0,16 - 0,38 (0,10 - 0,38)	175 - 525 (366 - 912)
25	4	Stützholm / Support strut / Hauban de châssis / Correnti di appoggio / Tirante vertical / Travessa de apoio / Опорный подкос			120 HC	3,78	0,15	0,22	200
					21 HC 290	4,14 (6,55)	0,18 (0,22)	0,25 (0,25)	320 (600)
26	1	Unterwagen-Turmstück / Undercarriage tower section / Mât de châssis / Elemento di torre del carro / Tramo de carro / Peça de torre do chassis / Опорная башенная секция			120 HC	3,50	2,06	2,06	1320
					21 HC 290	3,73 (6,70)	2,62 (2,53)	2,62 (2,53)	2550 (3800)
27	1	Stapel Aufstiege und Podeste / Bundle of ladders and platforms / Faisceau d'échelles et de plates-formes / Serie di scale e rampe / Paquete de escaleras y plataformas / Escadas e patamares / Лестницы и площадки			120 HC	3,50	1,20	1,00	1000
28	1	Kiste mit Kleinteilen / Crate with small parts / Caisse contenant des accessoires / Cassa con accessori / Caja con accesorios / Caixa de acessórios / Ящик с мелкими деталями				2,00	1,00	1,00	2000

() **Angaben in Klammern gelten für 8 m-Unterwagen.** / The data in brackets are valid for an undercarriage of 8 m. / Les données techniques indiquées entre parenthèses sont valables pour un châssis de 8 m. / Caratteristiche in (...) valgono per carro di 8 m. / Los datos entre paréntesis son válidos para carro de 8 m. / Características em (...) válidas pelo chassis de 8 m. / Данные в скобках относятся к 8-метровой опорной раме.

⁸⁾ **Einzelgewichte.** / Single weights. / Poids individuels. / Singoli pesi. / Pesos unitarios. / Pesos de peças componentes. / Индивидуальный вес.

⁹⁾ **Komfort-Kabine** / Deluxe cab / Cabine confort / Cabina comfort / Cabina confort / Cabine conforto / кабина повышенной комфортности

Konstruktionsänderungen vorbehalten! / Subject to alterations! / Sous réserves de modifications! / Reservato il diritto di modifiche strutturali! / ¡Sujeto a modificaciones! / Salvo modificação da construo! / Права на внесение конструкторских изменений сохраняются!

Sämtliche Angaben erfolgen ohne Gewähr. / This information is supplied without liability. / Ces renseignements sont sans garantie. / Tutte le indicazioni fornite senza garanzia. / Declinamos toda responsabilidad derivada de la información proporcionada. / Declinamos qualquer responsabilidade quanto à informação fornecida. / Все данные указаны без обязательств.